

PQ3RF23/PQ3RF33

3.3V Output, High Output Current(2A, 3.5A)Type Low Power-loss Voltage Regulators

Features

- 3.3V output
- High output current
2A type:PQ3RF23
3.5A type:PQ3RF33
- Compact resin full-mold package(TO-220 package)
- Low power-loss(Dropout voltage:MAX. 0.5V)
- High-precision output voltage type
Output voltage precision:±2.5%
- Built-in ON/OFF control function
- Built-in overcurrent protection, overheat protection function

Applications

- Power supplies for various electronic equipment such as personal computers

Outline Dimensions

(Unit : mm)

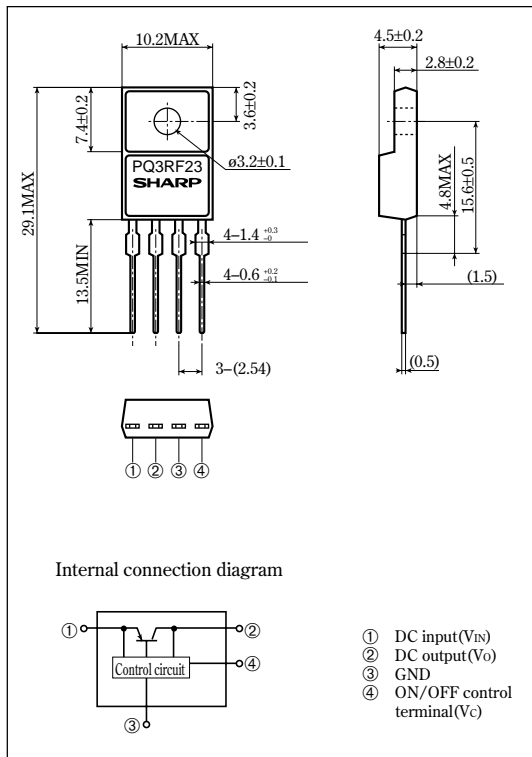

Absolute Maximum Ratings

(T_a=25°C)

Parameter	Symbol	Rating	Unit
*1 Input voltage	V _{IN}	10	V
*1 ON/OFF control terminal voltage	V _C	10	V
Output current	I _O	PQ3RF23	2
		PQ3RF33	3.5
Power dissipation(No heat sink)	P _{D1}	PQ3RF23	1.5
		PQ3RF33	1.8
Power dissipation(With infinite heat sink)	P _{D2}	18	W
*2 Junction temperature	T _J	150	°C
Operating temperature	T _{opr}	-20 to +80	°C
Storage temperature	T _{stg}	-40 to +150	°C
Soldering temperature	T _{sol}	260(For 10s.)	°C

*1 All are open except GND and applicable terminals.

*2 Overheat protection may operate at 125<=T_J<=150°C.

•Please refer to the chapter " Handling Precautions ".



Electrical Characteristics

(Unless otherwise specified, conditions shall be $I_o=1.0A$ [PQ3RF23]/ $I_o=1.5A$ [PQ3RF33], $V_{IN}=5V$, $T_a=25^\circ C$)

Parameter	Symbol	Conditions	MIN.	TYP.	MAX.	Unit	
Output voltage	V_o	-	3.218	3.3	3.382	V	
Load regulation	PQ3RF23 PQ3RF33	R_{egL}	$I_o=5mA$ to $2.0A$	-	0.2	2	%
			$I_o=5mA$ to $3.5A$	-	0.2	2	
Line regulation	R_{egI}	$V_{IN}=4$ to $10V$	-	0.5	2.5	%	
Temperature coefficient of output voltage	TcV_o	$T_j=0$ to $125^\circ C$	-	± 0.02	-	$\%/^\circ C$	
Ripple rejection	RR	-	45	55	-	dB	
Dropout voltage	PQ3RF23 PQ3RF33	V_{F-O}	$*3, I_o=2.0A$	-	-	0.5	V
			$*3, I_o=3.0A$	-	-	0.5	
$*4$ ON-state voltage for control	$V_{C(ON)}$	-	2	-	-	V	
ON-state current for control	$I_{C(ON)}$	$V_C=2.7V$	-	-	20	μA	
OFF-state voltage for control	$V_{C(OFF)}$	-	-	-	0.8	V	
OFF-state current for control	$I_{C(OFF)}$	$V_C=0.4V$	-	-	-0.4	mA	
Quiescent current	I_q	$I_o=0A$	-	-	10	mA	

*3 Input voltage shall be the value when output voltage is 95% in comparison with the initial value.

*4 In case of opening control terminal @, output voltage turns on.

Fig. 1 Test Circuit

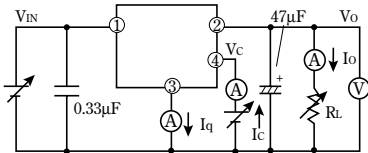

Fig. 2 Test Circuit of Ripple Rejection

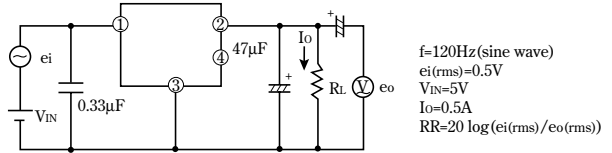
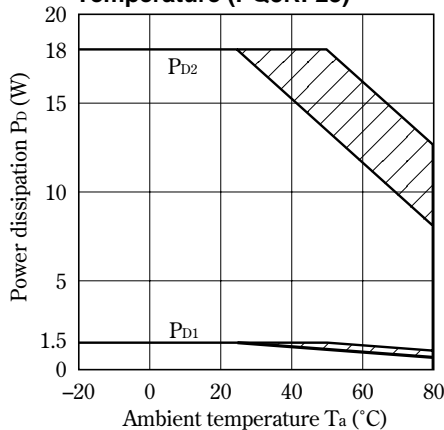
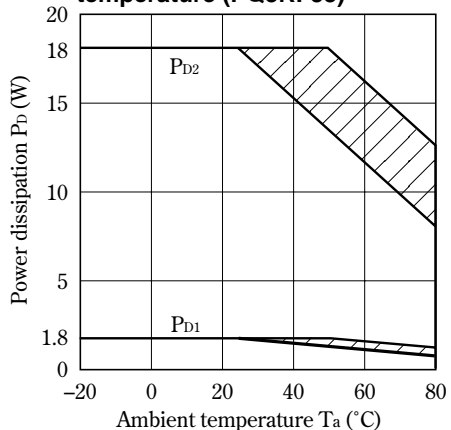

Fig. 3 Power Dissipation vs. Ambient Temperature (PQ3RF23)



Note) Oblique line portion : Overheat protection may operate in this area.

Fig. 4 Power dissipation vs. Ambient temperature (PQ3RF33)



Note) Oblique line portion : Overheat protection may operate in this area.

Fig. 5 Overcurrent Protection Characteristics (PQ3RF23)

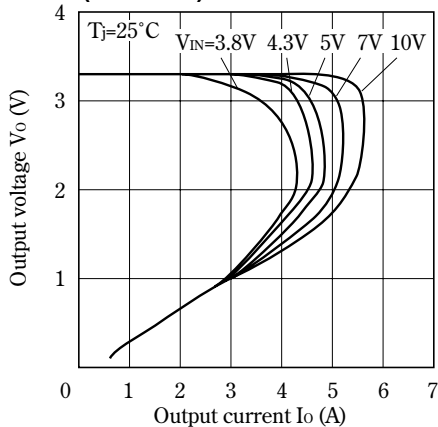

Fig. 6 Overcurrent Protection Characteristics (PQ3RF33)

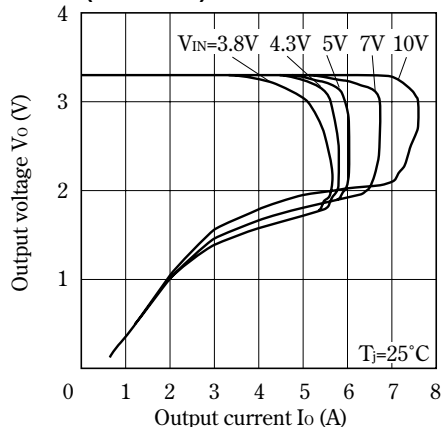

Fig. 7 Output Voltage Deviation vs. Junction Temperature (PQ3RF23)

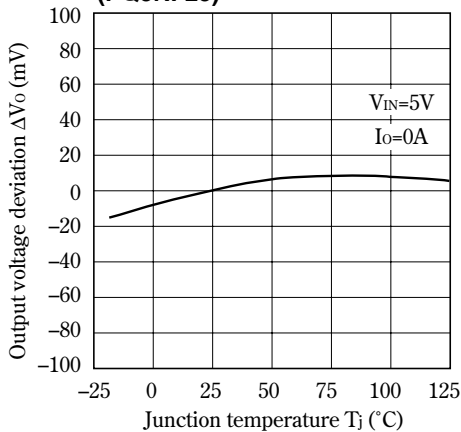

Fig. 8 Output Voltage Deviation vs. Junction Temperature (PQ3RF33)

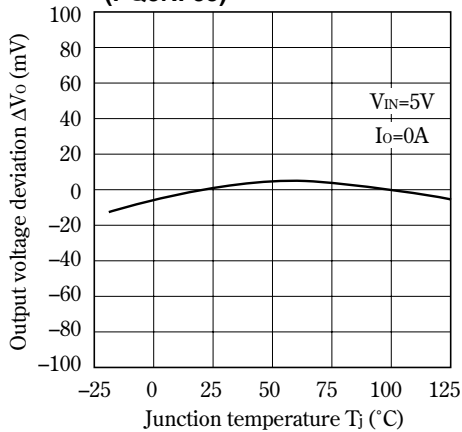

Fig. 9 Output Voltage vs. Input Voltage (PQ3RF23)

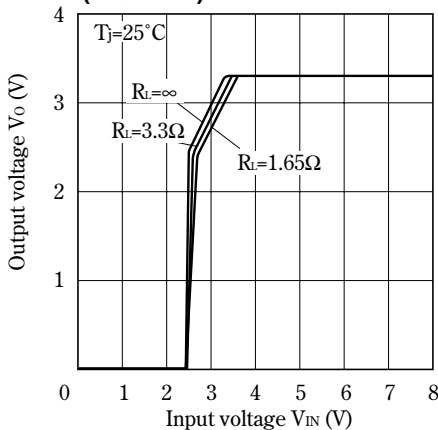

Fig.10 Output Voltage vs. Input Voltage (PQ3RF33)

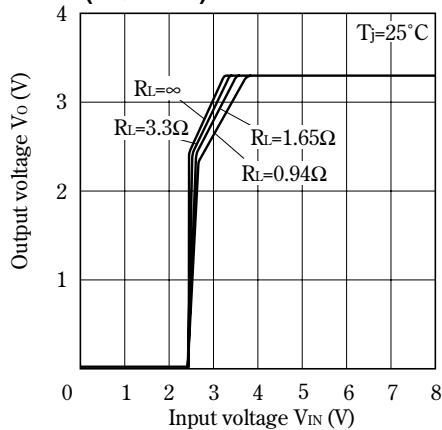

Fig.11 Circuit Operating Current vs. Input Voltage (PQ3RF23)

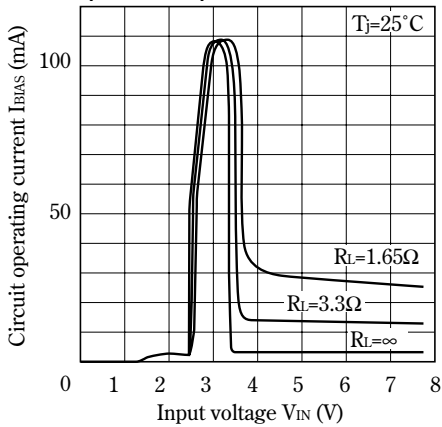

Fig.12 Circuit Operating Current vs. Input Voltage (PQ3RF33)

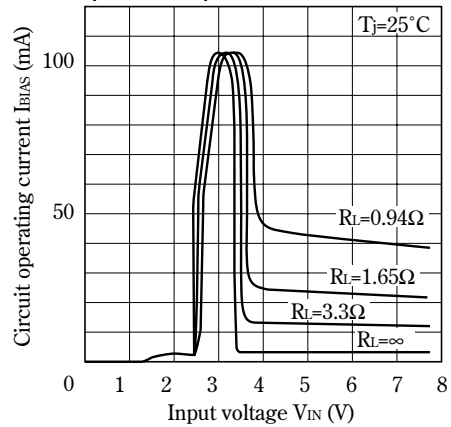

Fig.13 Dropout Voltage vs. Junction Temperature (PQ3RF23)

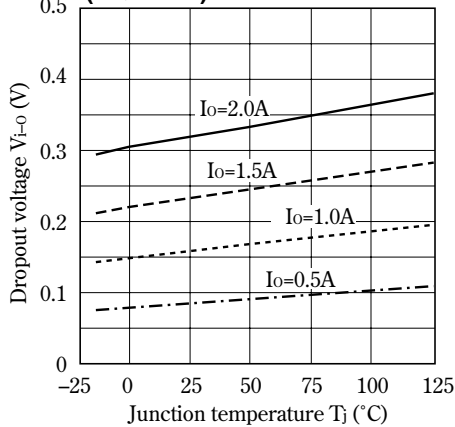

Fig.14 Dropout Voltage vs. Junction Temperature (PQ3RF33)

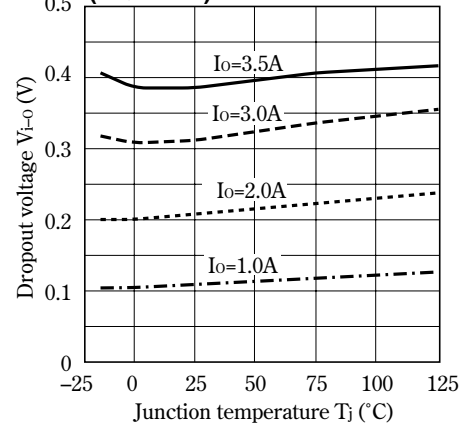

Fig.15 Quiescent Current vs. Junction Temperature (PQ3RF23)

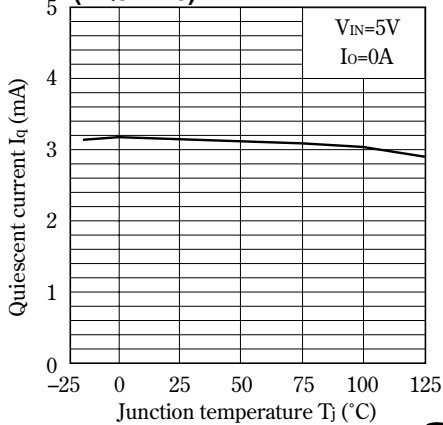

Fig.16 Quiescent Current vs. Junction Temperature (PQ3RF33)

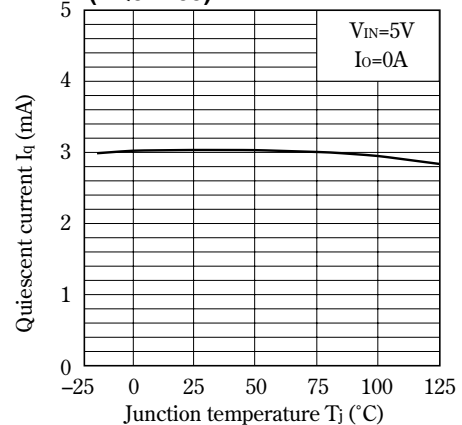

Fig.17 Ripple Rejection vs. Input Ripple Frequency (PQ3RF23)

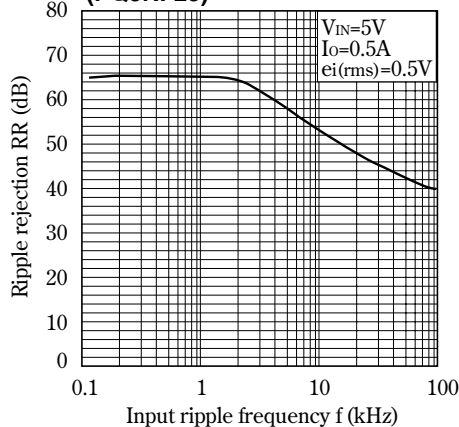

Fig.18 Ripple Rejection vs. Input Ripple Frequency (PQ3RF33)

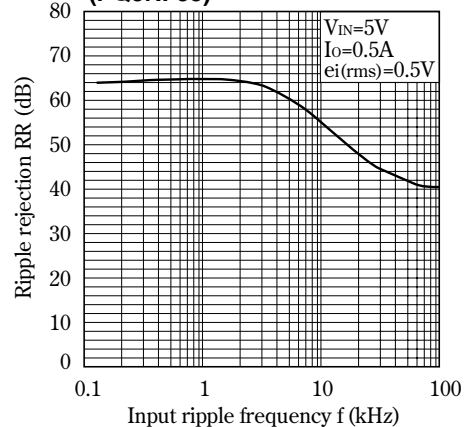

Fig.19 Ripple Rejection vs. Output Current (PQ3RF23)

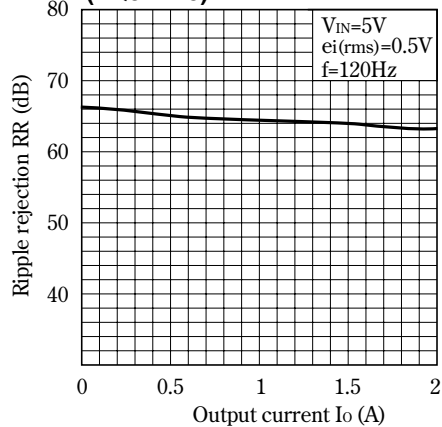

Fig.20 Ripple Rejection vs. Output Current (PQ3RF33)

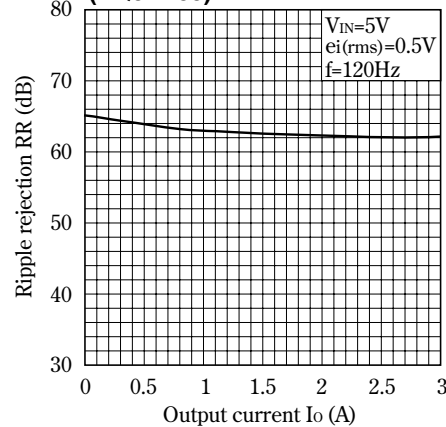

Fig.21 Output Peak Current vs. Junction Temperature (PQ3RF23)

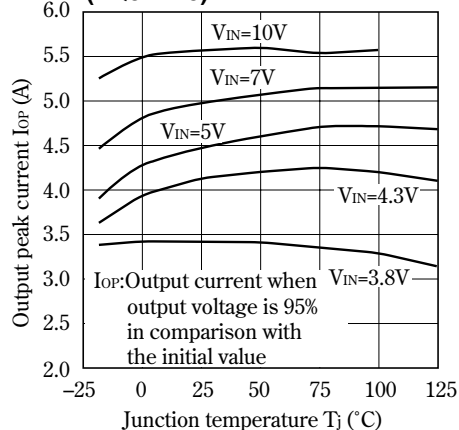
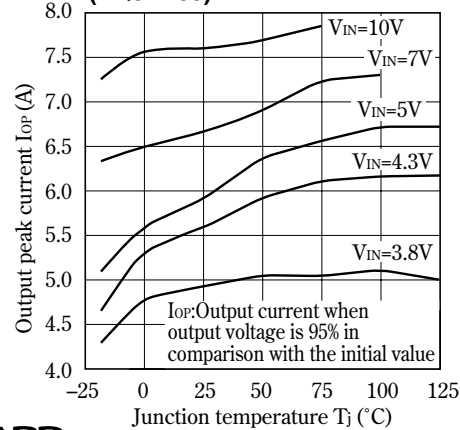
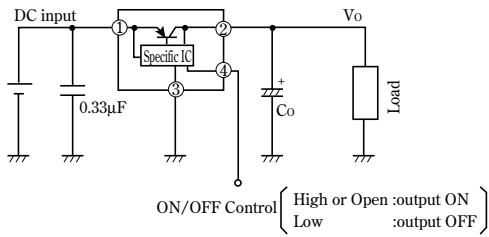

Fig.22 Output Peak Current vs. Junction Temperature (PQ3RF33)



■ Typical Application



NOTICE

- The circuit application examples in this publication are provided to explain representative applications of SHARP devices and are not intended to guarantee any circuit design or license any intellectual property rights. SHARP takes no responsibility for any problems related to any intellectual property right of a third party resulting from the use of SHARP's devices.
- Contact SHARP in order to obtain the latest device specification sheets before using any SHARP device. SHARP reserves the right to make changes in the specifications, characteristics, data, materials, structure, and other contents described herein at any time without notice in order to improve design or reliability. Manufacturing locations are also subject to change without notice.
- Observe the following points when using any devices in this publication. SHARP takes no responsibility for damage caused by improper use of the devices which does not meet the conditions and absolute maximum ratings to be used specified in the relevant specification sheet nor meet the following conditions:
 - (i) The devices in this publication are designed for use in general electronic equipment designs such as:
 - Personal computers
 - Office automation equipment
 - Telecommunication equipment [terminal]
 - Test and measurement equipment
 - Industrial control
 - Audio visual equipment
 - Consumer electronics
 - (ii) Measures such as fail-safe function and redundant design should be taken to ensure reliability and safety when SHARP devices are used for or in connection with equipment that requires higher reliability such as:
 - Transportation control and safety equipment (i.e., aircraft, trains, automobiles, etc.)
 - Traffic signals
 - Gas leakage sensor breakers
 - Alarm equipment
 - Various safety devices, etc.
 - (iii) SHARP devices shall not be used for or in connection with equipment that requires an extremely high level of reliability and safety such as:
 - Space applications
 - Telecommunication equipment [trunk lines]
 - Nuclear power control equipment
 - Medical and other life support equipment (e.g., scuba).
- Contact a SHARP representative in advance when intending to use SHARP devices for any "specific" applications other than those recommended by SHARP or when it is unclear which category mentioned above controls the intended use.
- If the SHARP devices listed in this publication fall within the scope of strategic products described in the Foreign Exchange and Foreign Trade Control Law of Japan, it is necessary to obtain approval to export such SHARP devices.
- This publication is the proprietary product of SHARP and is copyrighted, with all rights reserved. Under the copyright laws, no part of this publication may be reproduced or transmitted in any form or by any means, electronic or mechanical, for any purpose, in whole or in part, without the express written permission of SHARP. Express written permission is also required before any use of this publication may be made by a third party.
- Contact and consult with a SHARP representative if there are any questions about the contents of this publication.